

## INSTALLATION MANUAL

# Low Ambient Control Kit

- Please read this installation manual completely before installing the product.
- Installation work must be performed in accordance with the national wiring standards by authorized personnel only.
- Please retain this installation manual for future reference after reading it thoroughly.

**MODEL : PRVC2**

\* PRVC2 is available only for the Multi-V IV model  
(PRVC2 can not be installed for the previous Multi-V IV model)



P/NO : MFL42540228

[www.lg.com](http://www.lg.com)

# TABLE OF CONTENTS

■ Safety Precautions.....	3
■ Accessory Parts .....	6
■ Name of each Part .....	7
■ Installation Method.....	8
1. IO Module Installation Method.....	8
2. Transformer, Terminal Block Installation Method.....	10
■ Setting and Using Method .....	12
1. Wiring Diagram .....	12
2. Power Source Input .....	13
3. IO Module - Low Ambient Kit Function.....	15
4. IO Module – Other Function .....	16
5. Wiring for Damper Actuator.....	19
6. Setting of Outdoor Unit Dip Switch.....	22
■ Installation Method of Snow Hood and Air Damper .....	23
1. One Unit with Snow Hood and Air Damper .....	23
2. Two and Three Units with Snow Hood and Air Damper .....	24
3. Unit Placement and Clearances.....	25

# Safety Precautions



To prevent injury to the user or other people and property damage, the following instructions must be followed.

- Incorrect operation due to ignoring instruction will cause harm or damage. The seriousness is classified by the following indications.

**⚠ WARNING** This symbol indicates the possibility of death or serious injury.

**⚠ CAUTION** This symbol indicates the possibility of injury or damage.

- Meanings of symbols used in this manual are as shown below.

	<b>Be sure not to do.</b>
	<b>Be sure to follow the instruction.</b>

**⚠ WARNING**

## ■ Installation

**Don't touch with the hands while the power is on.**

- Cause fire, electric shock, explosion or injury.

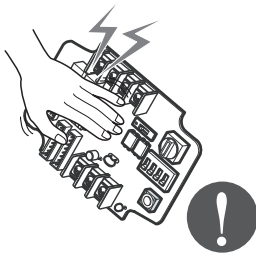

**Product installation must be referred to a service center or installation shop.**

- Cause fire, electric shock, explosion or injury.

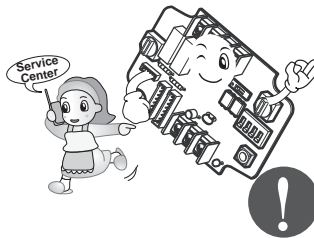

**Request installation from installation shop or service center when reinstalling the product.**

- Cause fire, electric shock, explosion or injury.



**Do not install the product in the place where rain can get to the product.**

- Cause product failure

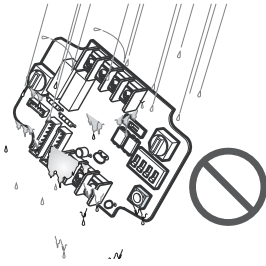

**Do not install the unit in humid locations.**

- Cause product failure

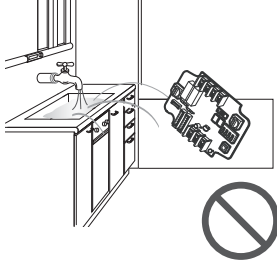

**Do not put the product closer to fire.**

- Cause fire

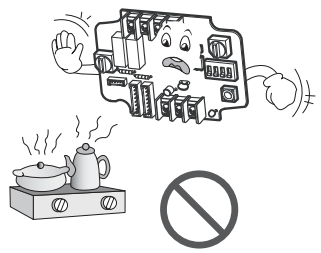

**Do not install in a place that cannot withstand the weight of the product.**

- The product may get damaged or may break.

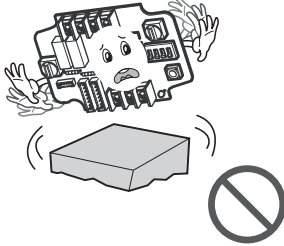

**Do not install the product to a place that generates oil, steam, salt, sulfuric gas, etc.**

- Cause the product's deformation or failure.



**Use standardized Product.**

- Cause product failure

**Standardized product**

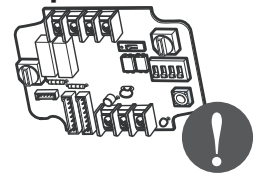

**■ Operation**

**Do not change or extend power lines arbitrarily.**

- Cause fire or electric shock.

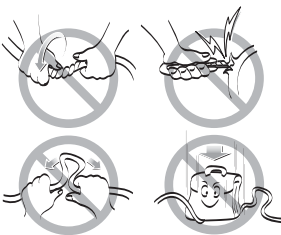

**Do not give a shock to the product.**

- If you give a shock to the product, it may cause the product's failure.

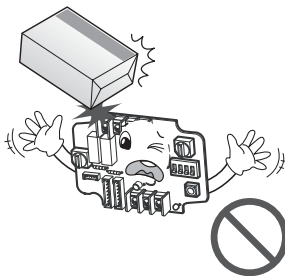

**Do not use a heater near the power line.**

- Cause fire or electric shock.

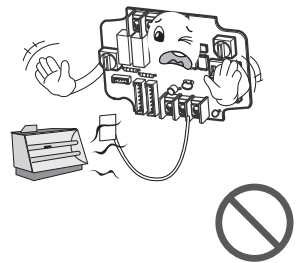

**Do not spill water inside of the product.**

- Cause electric shock or breakdown.

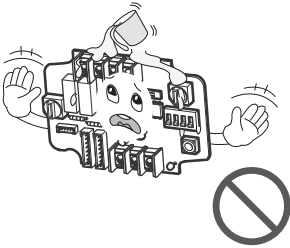

**If the product has been inundated, you must refer to a service center or installation shop.**

- It can cause a fire.



**Children and elderly use the product under the guardian's supervision.**

- Cause accidents and product failures.

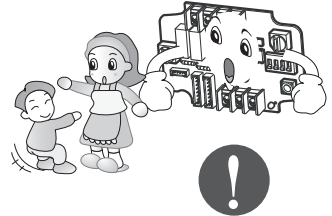

**Do not use for special purpose / place such as conserving flora and fauna, precision instruments, art.**

- Otherwise, it can cause property damage.

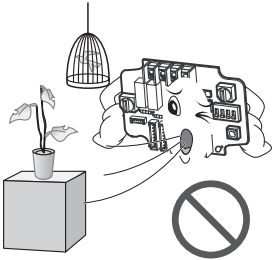

**Remove the power plug when cleaning.**

- Cause fire or electric shock.

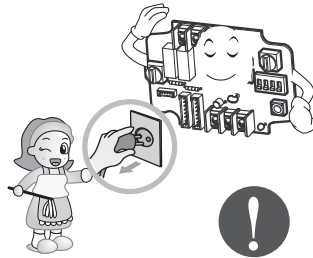

**Do not place heavy objects on the power line.**

- Cause fire or electric shock.

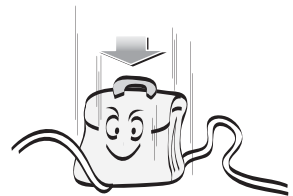

**Do not disassemble, repair, or modify the product.**

- Cause fire or electric shock.

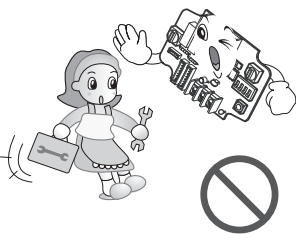

**Do not touch with wet hands.**

- Cause fire or electric shock.

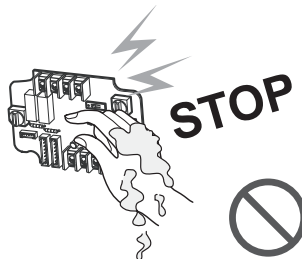

# Accessory Parts

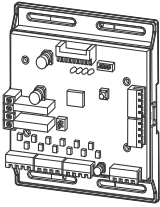

IO Module

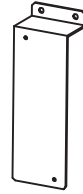

Bracket 1

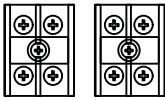

Terminal Block (2EA)

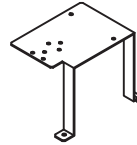

Bracket 2

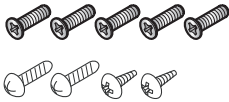

Screw (9EA)



Manual

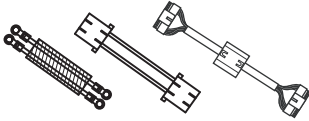

Cable (3EA)



Tie (2EA)

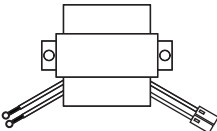

Transformer



Clamp

# Name of each Part

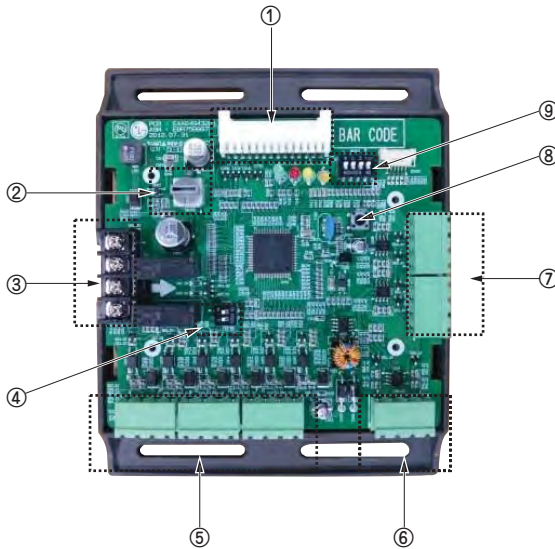

- ① **Main connector** : Power input and communication connector with Outdoor unit
- ② **SW104** : Rotary Switch for setting Demand control step
- ③ **Digital Output** : Operating & Error status Relay output (250V, 1A)
- ④ **SW102** : Switch for setting internal function
- ⑤ **Digital Input** : Dry contact input
- ⑥ **Analog Input** : DC0~10V Analog signal input
- ⑦ **Analog Output** : DC0~10V Analog signal output
- ⑧ **SW103** : Reset Switch
- ⑨ **SW101** : Dip Switch for setting operating function

# Installation Method

## 1. IO Module Installation Method

- ① Separate front panel from outdoor unit.
- ② Separate front cover of control box.
- ③ Assemble IO Module and bracket.
- ④ Connect the connection wires according to the instructions. (Please refer to Setting and Using Method)

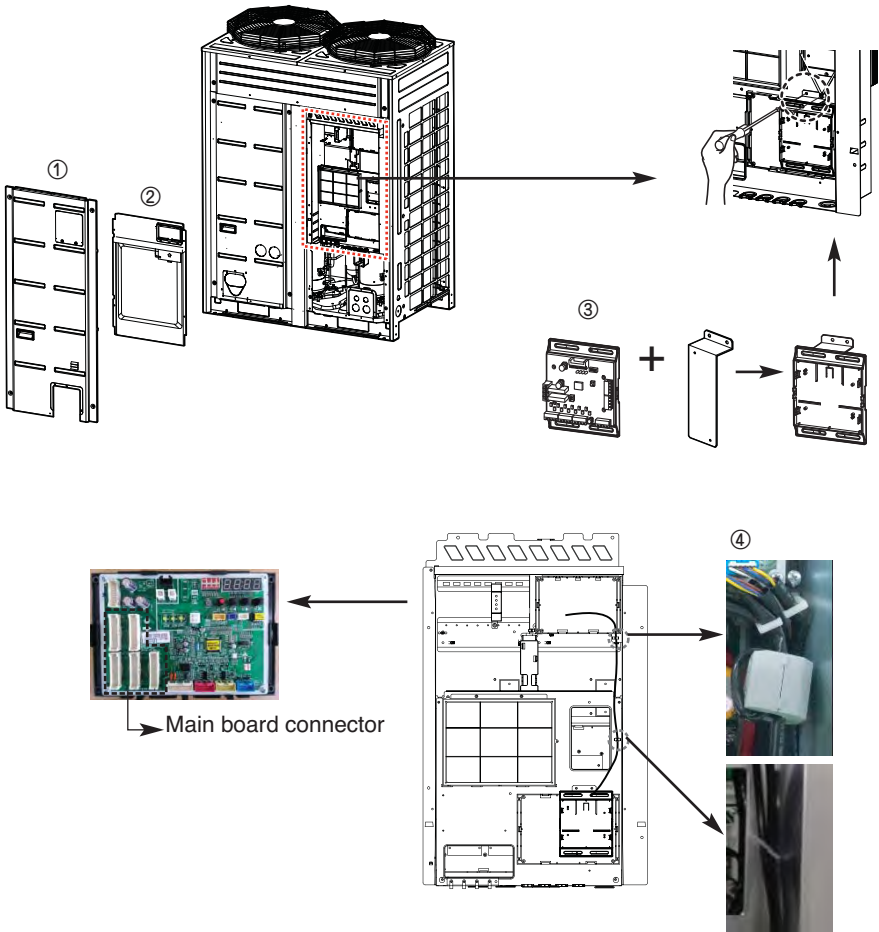

### ⚠ CAUTION

Be sure to turn off outdoor unit power before installation.



- ⑤ Fix and fasten components and cables.
- ⑥ Perform the switch setting according to the instructions.

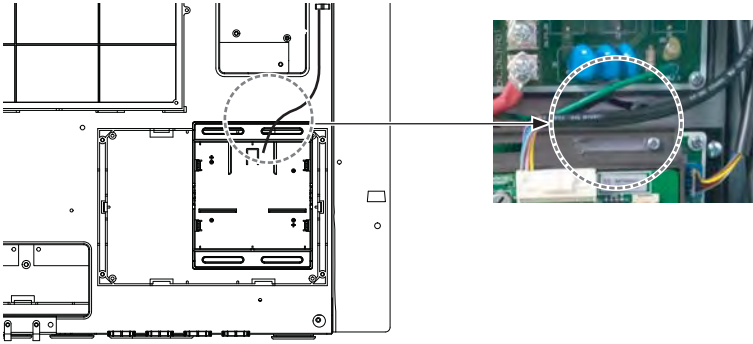

## 2. Transformer, Terminal Block Installation Method

- ① Shut off the main power of outdoor unit.
- ② Install the IO Module in the C/Box by using screws.
- ③ Install the Bracket2 in the C/Box by using screws.
- ④ Install the transformer on the Bracket2 by using screws.
- ⑤ Install the terminal block on the Bracket2 by using screws.
- ⑥ Connect the Main PCB(CN10) to IO Module(CN101) by using the cable assembly.
- ⑦ Connect the blue cable of transformer to the Main PCB(JIG\_N), brown cable of transformer to the Main PCB(JIG\_L).
- ⑧ Connect the red cable of transformer to the terminal block (2Pin Yellow terminal block).
- ⑨ Connect a power cable(DC 12V) to CN101(12V,GND) of IO Module.
- ⑩ Connect the black cable of Damper Actuator to the terminal block and connect the cable of IO Module(CN1\_A0(GND(A-)) to the black cable of Damper Actuator.
- ⑪ Connect the red cable of Damper Actuator to CN1\_A0(A0\_1(A+)) of IO Module.
- ⑫ Set up the main function Dip S/W of IO Module.  
(SW101 : L1,L2=On and L3,L4=Off / SW102 : L1,L2=Off)
- ⑬ Set up the Dip S/W of Main Outdoor unit PCB. (Refer to page 21 for details)
- ⑭ Turn on the main power of outdoor unit.
- ⑮ Check the signal to CN1\_A0(AO\_01,GND) of IO Module and Air Damper.

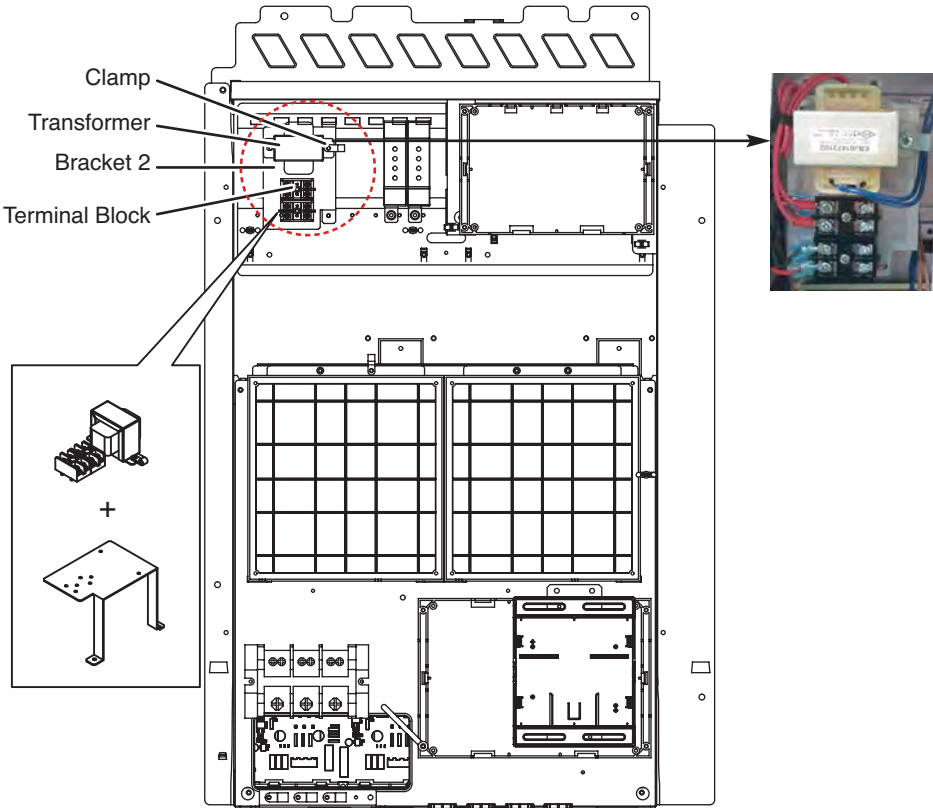

Using the Clamp and Tie, fasten the Damper Actuator output cable and Trans output cable as below.

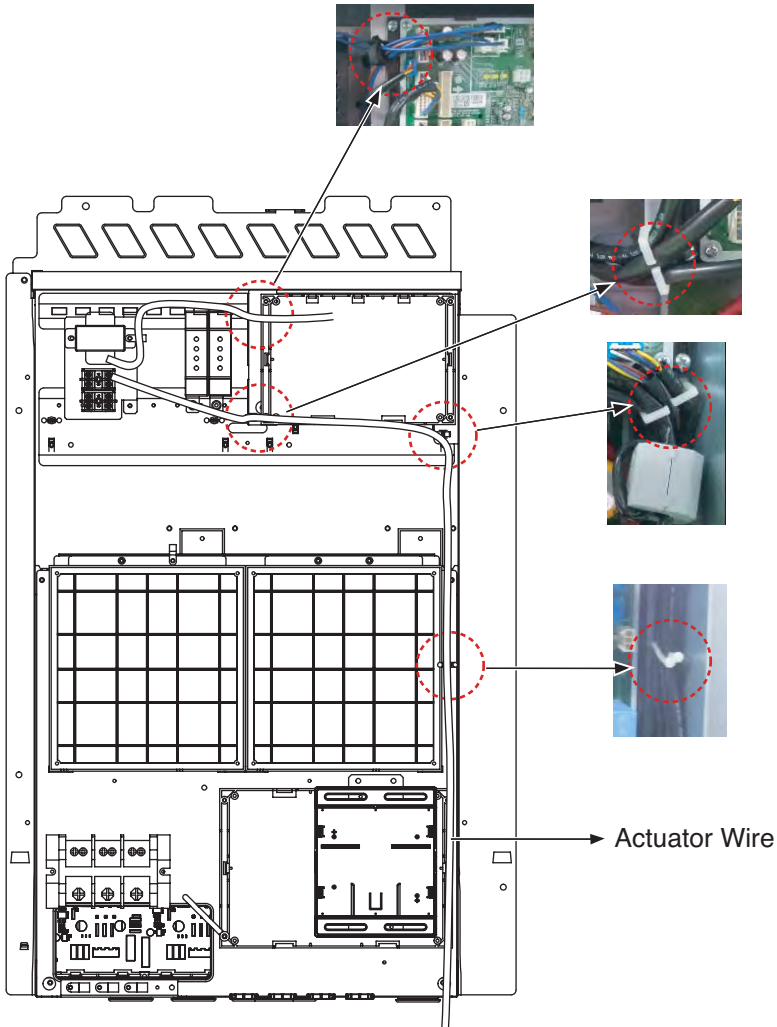

# Setting and Using Method

## 1. Wiring Diagram

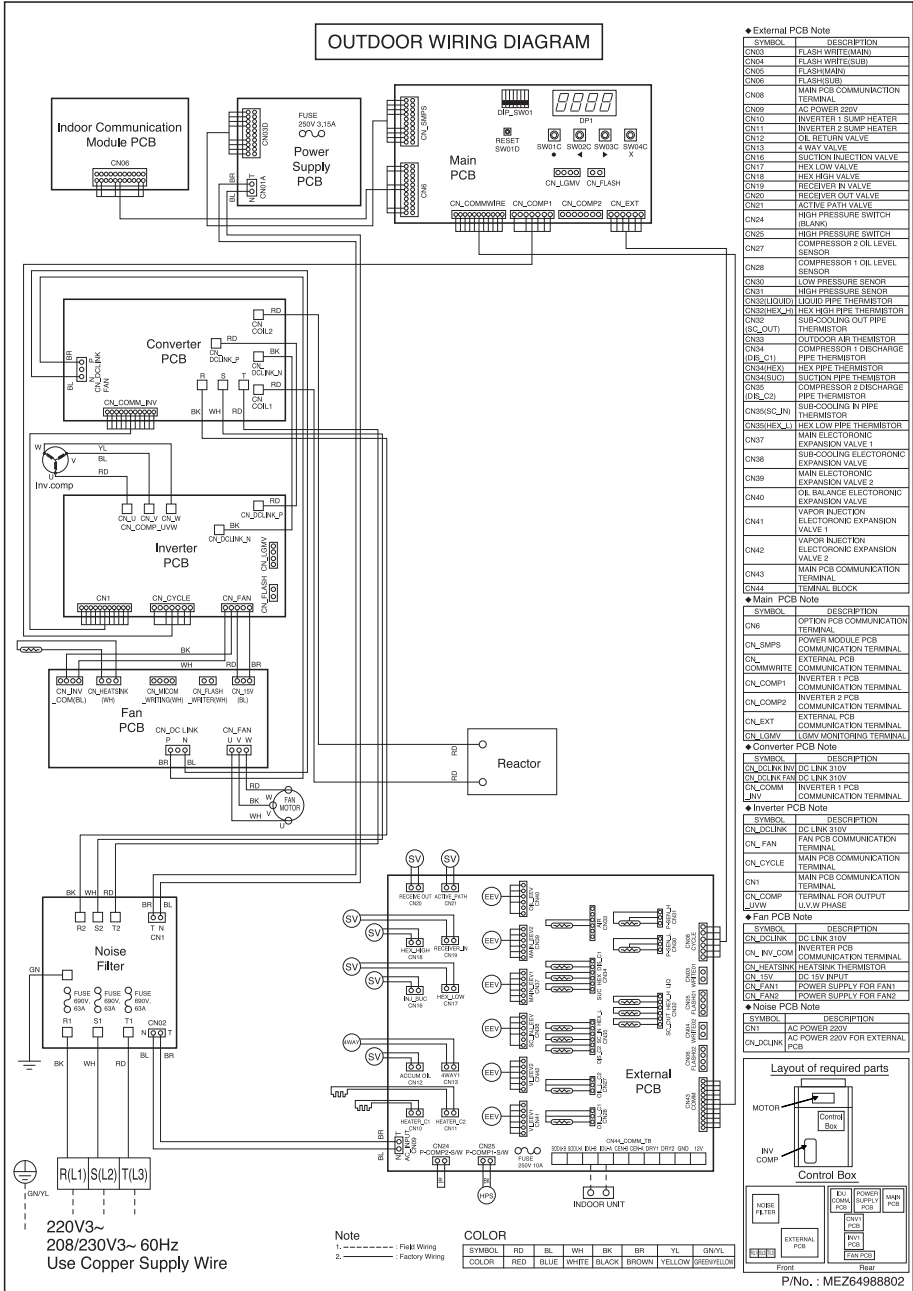

## 2. Power source input

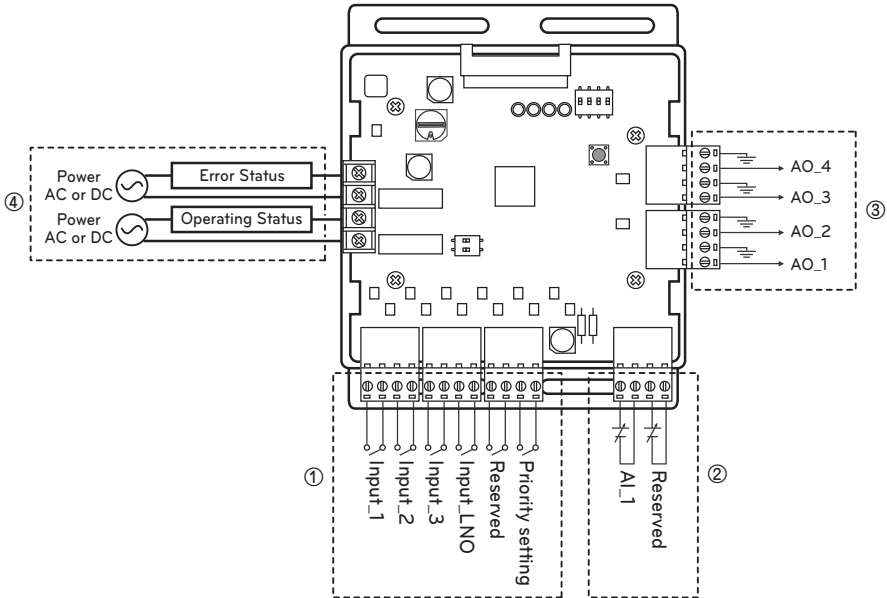

AI : Analog Input (DC0~10V)

AO : Analog Output ( DC0~10V, Max 20mA)

Input\_LNO : Low Noise Operation

### ① Dry contact input part

Connect Non Voltage contact signal for demand control (3 step)

\* Priority setting

Using 'Priority setting' contact signal, set the priority of command.

(External command from DDC Vs Command from LG central controller.)

- Close : Central controller has priority to external signal.
- Open : External signal has priority to central controller.

### ② Analog input part

Connect Analog input signal for demand control (10 step)

### ③ Analog output part

Connect Analog output signal for controlling third party devices.

Ex) Valve actuator for variable water flow. Damper actuator for Low Ambient Kit

### ④ Digital output part

Connect status display devices.

## ⚠ CAUTION

Power must be turned on after the product is wired completely.

## ■ Communication and Power Line

- If communication and power lines are run alongside each other then there is a strong likelihood of operational faults developing due to interference in the signal wiring caused by electrostatic and electromagnetic coupling. The tables below indicates our recommendation as to appropriate spacing of communication and power lines where these are to be run side by side.

Current capacity of power line		Spacing
100V or more	10A	11-13/16 in (300 mm)
	50A	19-11/16 in (500 mm)
	100A	39-3/8 in (1,000 mm)
	Exceed 100A	59-3/64 in (1,500 mm)

### Notes

If the power supply waveform continues to exhibit some distortion the recommended spacing in the table should be increased.

- If the lines are laid inside conduits then the following point must also be taken into account when grouping various lines together for introduction into the conduits.
- Power lines (including power supply to air conditioner) and signal lines must not be laid inside the same.
- In the same way, when grouping the lines power and signal lines should not be bunched together.

### 3. IO Module - Low Ambient Kit Function

#### Setting of Dip Switch

Using 'SW101', 'SW102', You can use Low Ambient Kit Mode

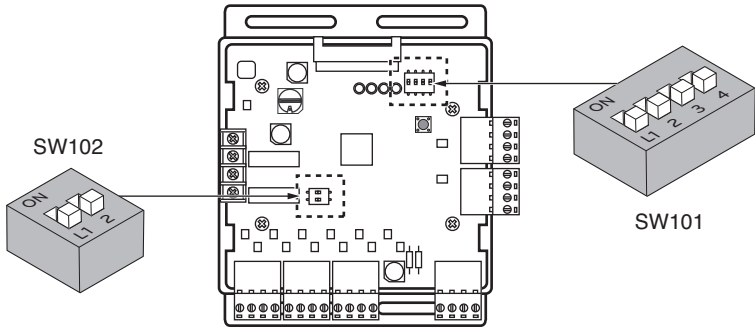

#### Notes

Default status is all off.

#### Set Low Ambient Kit Operation

Position	Setting of Dip Switch
	SW101 - L1=ON L2=ON L3=OFF L4=OFF
	SW102 - L1=OFF L2=OFF

#### **⚠ CAUTION**

- If the Dip SW is set, IO module System is operating preferentially than outdoor unit setting.
- After change Dip SW setting, press reset switch to reflect the setting.

## 4. IO Module – Other Function

### Setting of Dip Switch

Using 'SW101', select the option of control function as described below.

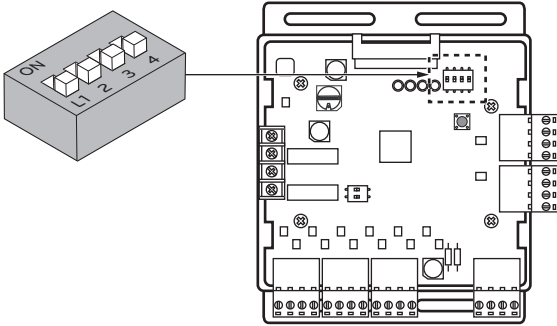

**Notes**

Default status is all off.

- L3 : Set Low Noise Operation

This is a function driving outdoor unit fan RPM to operate low speed for reducing fan noise according to the input signal. To use this function, you should set Outdoor unit mode, Please refer to PDB more detail.

Position	Function
	ON : Enable Low Noise Operation OFF : Disable Low Noise Operation

**! CAUTION**

If the Dip SW is set , IO module System is operating preferentially than outdoor unit setting.

- L4 : Set Operating status output

Position	Function
	ON : Activate Digital Output according to Indoor Unit status OFF : Activate Digital Output according to Outdoor Unit status

**! CAUTION**

After change Dip SW setting, press reset switch to reflect the setting.



Using 'SW102', set the internal function as described below.

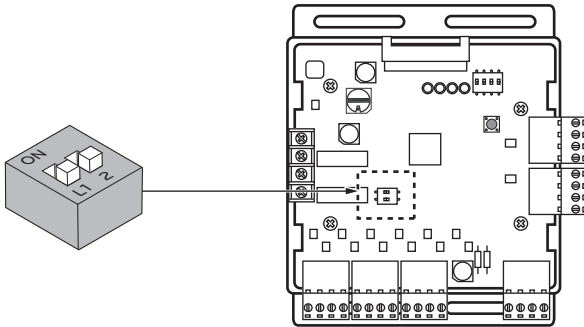

**Notes**

Default status is all off.

- L1 : Set Analog output default value when Communication Error will be occur (Module – ODU)

Position	Function
	ON : Analog output 0V OFF : Analog output 10V

- L2 : Set Analog output Range  
 Basically this module keeps a minimum Analog output voltage refer to L1,L2 setting of SW101 to prevent unexpected accident. When you need to use 0~10V full range, L2 should be set as ON.

Position	Function
	ON : Ignore minimum Analog output value setting (L1,L2 setting value of 4pin Dip SW) OFF : Follow minimum Analog output value setting (L1,L2 setting value of 4pin Dip SW)

**⚠ CAUTION**

After change Dip SW setting, press reset switch to reflect the setting.

## Setting of Rotary Switch

Use the Rotary Switch to set a control step for contact signal input : The type of input signal and control step can be set using 'SW104'

This function is for demand control to reduce power consumption.

Set the control mode what you want according to the table as below.

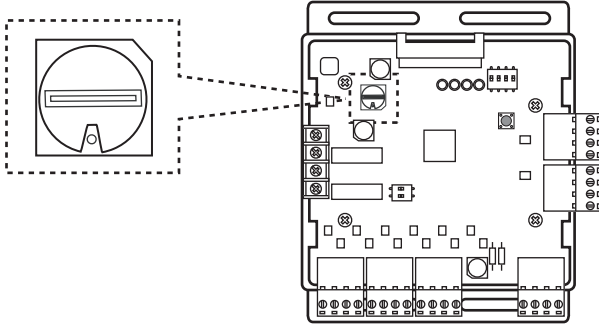

- Type of input signal

SW_STEP	Input signal
0, 1, 2, 3, 4, 5, 6, 7	Contact signal input
C, D, E	Analog input signal

### **⚠ CAUTION**

Do not change a command too quickly.

Keep the command 30 seconds at least, otherwise it will cause a damage to outdoor unit.

- Operation rate condition :
  - Cooling : Outdoor 35 °C, Indoor 27 °C
  - Heating : Outdoor 7 °C, Indoor 20 °C
- The tolerance of the operation rate can be cause by combination of outdoor unit, operating condition, installation circumstance.
- When operation rate is 100%, Target Evaporating Temp. and Target Condensing Temp. can be changed by installation option. (Refer to product data book)
- Input\_1 : 0 'E OFF, Input\_1 : 1 'E ON

## 5. Wiring for Damper Actuator

### 1 Unit

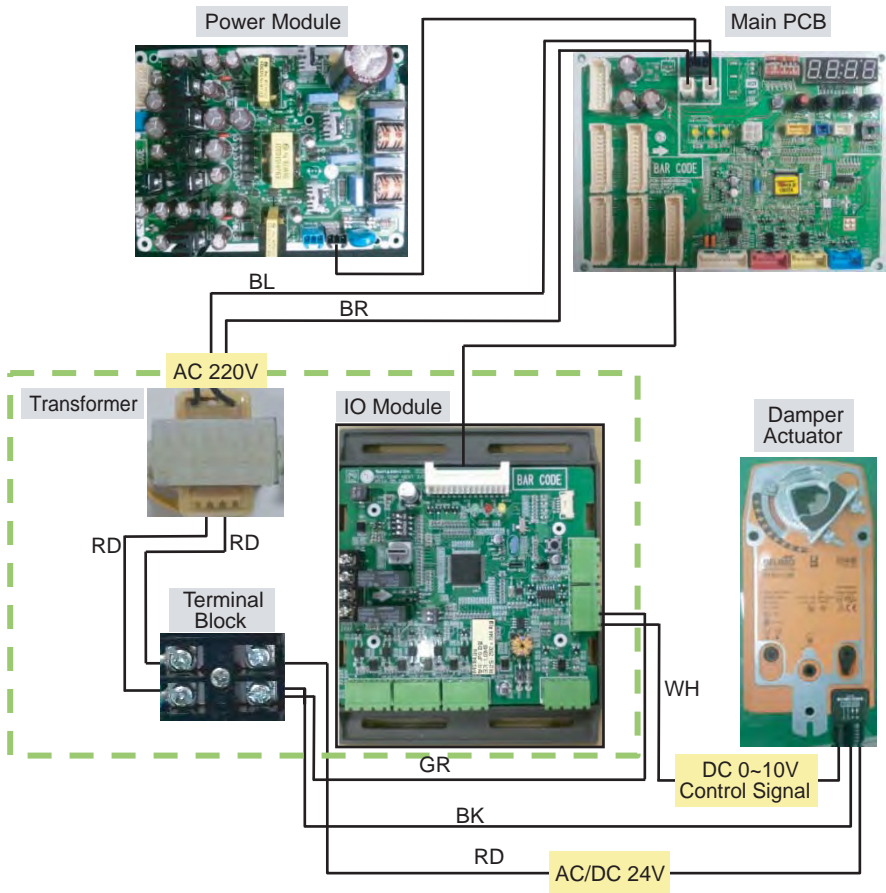

\* BL : Blue, BR : Brown, RD : Red, BK : Black, WH : White, GR : Green

#### Notes

Damper Actuator can accept only DC 24V power input.

Do not input AC power. Otherwise it will cause a serious damage.

The IO Module can control maximum three actuators.

Case of one valve, the slave signal connector must not use.

The power (AC/DC 24V) and signal(DC 0~10V) line is recommended by AWG22(1/32 in, (0.644 mm), 0.016 Ω/ft (0.053 Ω/m)).

## 2 Unit

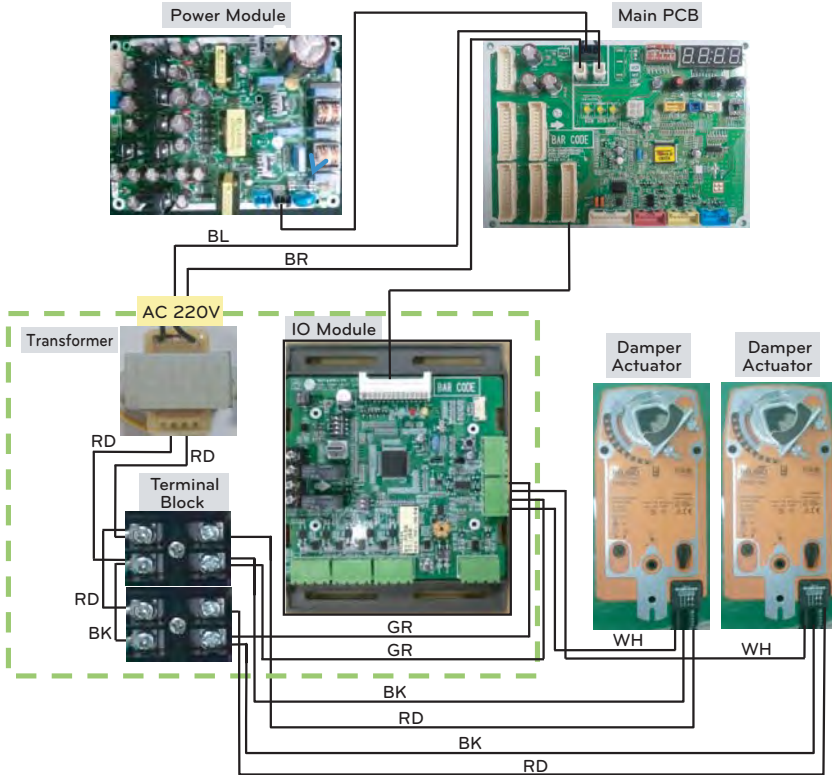

### Notes

Damper Actuator can accept only DC 24V power input.  
Do not input AC power. Otherwise it will cause a serious damage.  
The IO Module can control maximum three actuators.  
Case of one valve, the slave signal connector must not use.  
The power (AC/DC 24V) and signal(DC 0~10V) line is recommended by AWG22(1/32 in, (0.644 mm), 0.016 Ω/ft (0.053 Ω/m)).

## 3 Unit

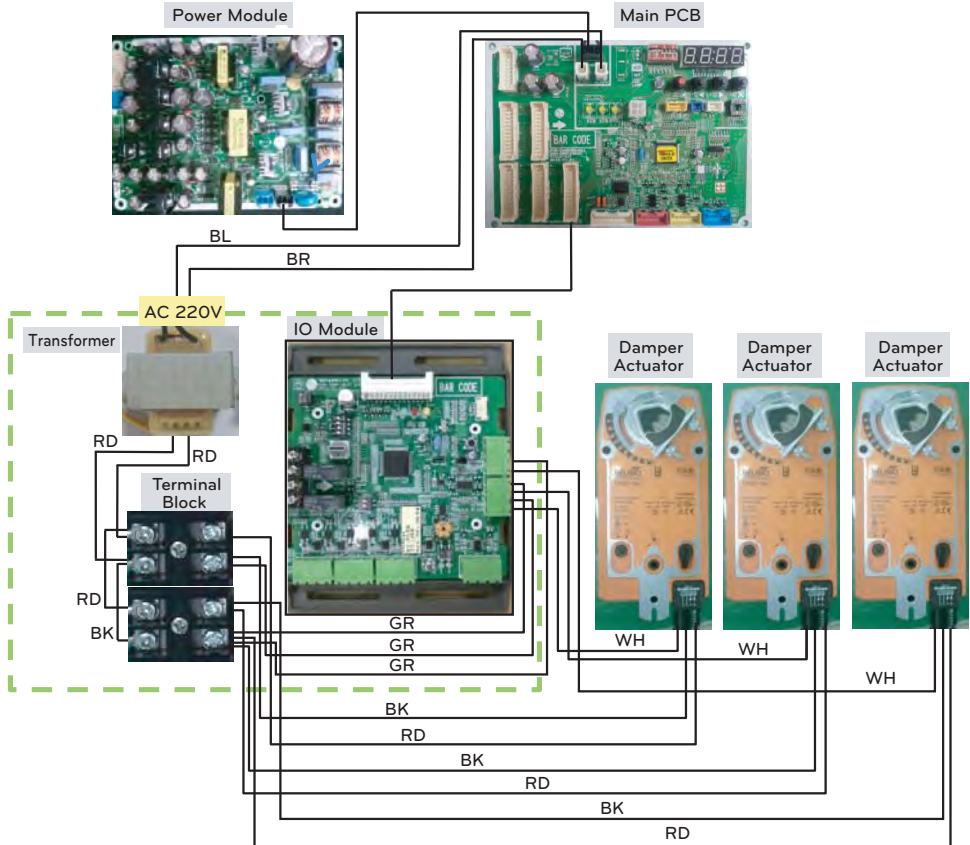
**Notes**

Damper Actuator can accept only DC 24V power input.

Do not input AC power. Otherwise it will cause a serious damage.

The IO Module can control maximum three actuators.

Case of one valve, the slave signal connecter must not use.

The power (AC/DC 24V) and signal (DC 0~10V) line is recommended by AWG22(1/32 in, (0.644 mm), 0.016 Ω/ft (0.053 Ω/m)).

## 6. Setting of Outdoor Unit Dip Switch

### Low Ambient Kit Mode

- Low Ambient Kit mode Setting method

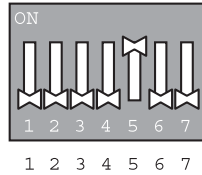
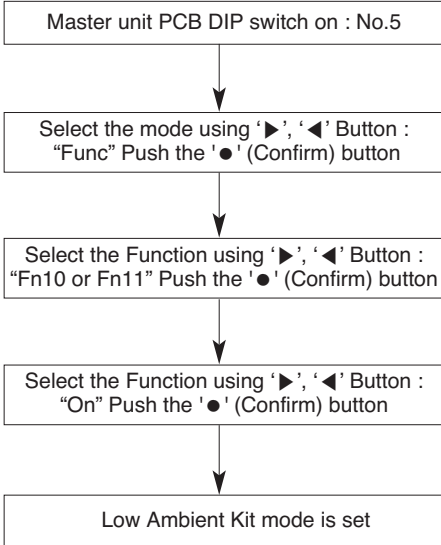

DIP SWITCH 7-Segment

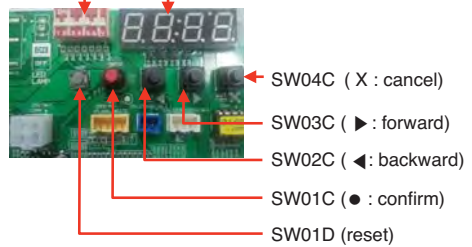

\* If you want to stop the Low Ambient Kit mode, refer to the following.

▷ Dip Switch No.5 On -> "Func" -> "Fn10" -> "Off"

\* Fn10 Model : ARUB\*\*\*BTE4

ARUB\*\*\*DTE4

ARUB\*\*\*LTE4

Fn11 Model : ARUN\*\*\*BTE4

ARUN\*\*\*DTE4

ARUN\*\*\*LTE4

ARUN\*\*\*LTS4

# Installation Method of Snow Hood and Air Damper

## 1. One Unit with Snow Hood and Air Damper

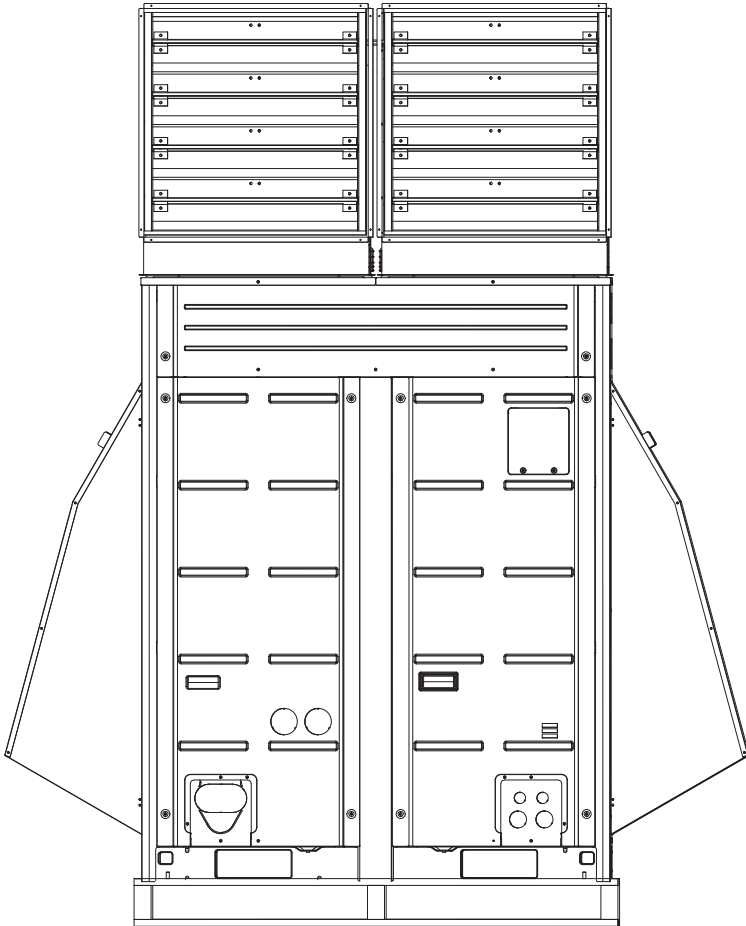

One Unit with Snow Hood and Air Damper

**2. Two and Three Units with Snow Hood and Air Damper**

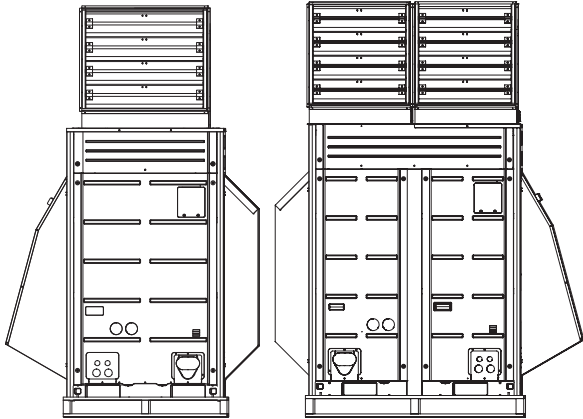

Two Units with Snow Hood and Air Damper

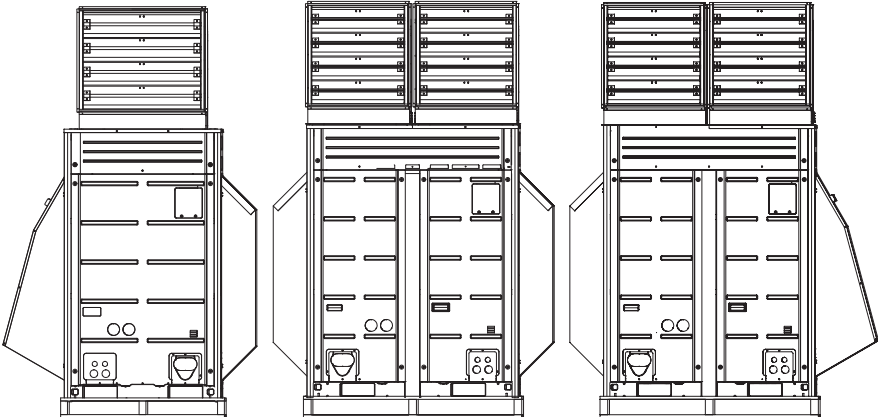

Three Units with Snow Hood and Air Damper



### 3. Unit Placement and Clearances

- Outdoor units should be located in an area protected from prevailing winds. (shown below)  
In high wind locations it may be advisable to locate the units within a walled area.

**Top View**

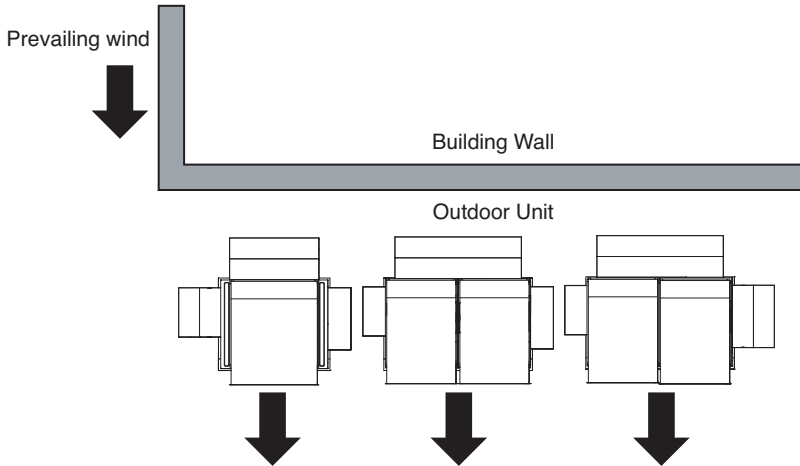

- If the units are surrounded by an enclosure, the discharge of the air damper must direct the air out and over the enclosure walls to prevent air recirculation.

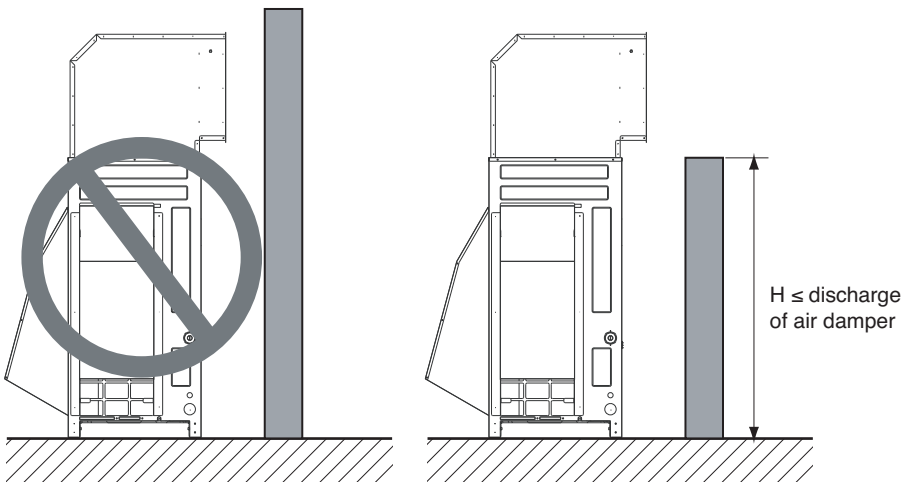

3. When the distance is less than 7-7/8in(200mm) between outdoor units, do not necessary installation of side Snow Hood as below.

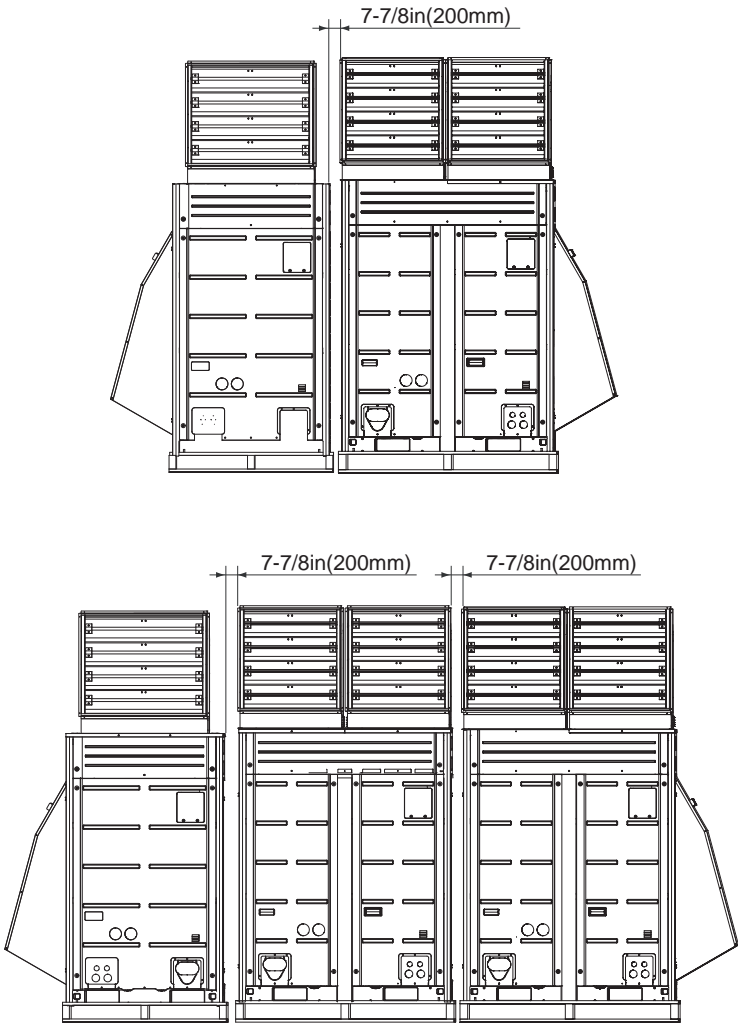

4. If units are placed further than 7-7/8in(200mm) apart, additional snow hoods may be required.

